



MIL-DTL-5015 MS,



-
-
-
-
-
-
-
-

3000

(RMS)

/



-
-
-
-
-

()



MIL-C-5015 MS

MIL-C-5015

/



MIL-DTL-5015



MS-A

MS-A

16 12

MIL-C-5015

MS3100A

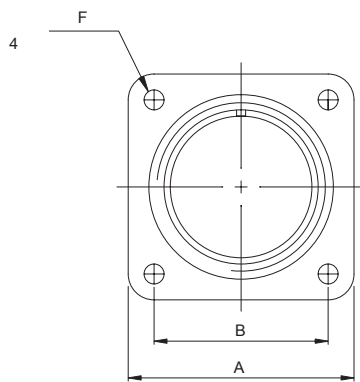

MS3100A

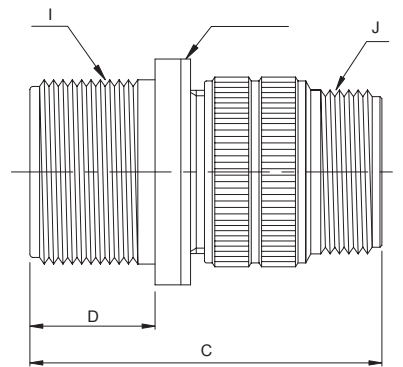

MS3057

(mm)

	□A ±0.79	□B ±0.12	C Max	D +0.79 -0.00	∅F +0.25 -0.12	I UNEF-2A	J UNEF
10SL	25.40	18.26	38.88	14.28	3.20	5/8-24 NEF	5/8-24 NEF
12S	27.79	20.62	42.87	14.28	3.20	3/4-20 NEF	5/8-24 NEF
12	27.79	20.62	52.37	19.05	3.20	3/4-20 NEF	5/8-24 NEF
14S	30.18	23.01	42.87	14.28	3.20	7/8-20 NEF	3/4-20 NEF
14	30.18	23.01	52.37	19.05	3.20	7/8-20 NEF	3/4-20 NEF
16S	32.54	24.61	42.87	14.28	3.20	1-20 NEF	7/8-20 NEF
16	32.54	24.61	52.37	19.05	3.20	1-20 NEF	7/8-20 NEF
18	34.93	26.97	52.37	19.05	3.20	1 1/8-18 NEF	1-20 NEF
20	38.10	29.36	55.57	19.05	3.20	1 1/4-18 NEF	1 3/16-18 NEF
22	41.28	31.75	55.57	19.05	3.20	1 3/8-18 NEF	1 3/16-18 NEF
24	44.45	34.93	58.72	20.63	3.73	1 1/2-18 NEF	1 7/16-18 NEF
28	50.80	39.67	58.72	20.63	3.73	1 3/4-18 NS	1 7/16-18 NEF
32	57.15	44.45	67.92	22.23	4.39	2-18 NS	1 3/4-18 NS
36	63.50	49.23	67.92	22.23	4.39	2 1/4-16 UN	2-18 NS

MIL-C-5015

MS3101A

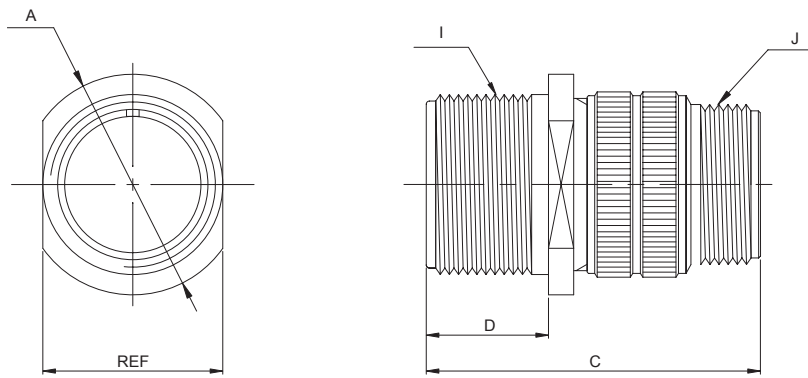

MS3101A

(mm)

	\varnothing A Max	C Max	D +0.79 -0.00	I UNEF-2A	J UNEF-2A
10SL	24.61	38.88	14.28	5/8-24 NEF	5/8-24 NEF
12S	26.97	42.87	14.28	3/4-20 NEF	5/8-24 NEF
12	26.97	52.37	19.05	3/4-20 NEF	5/8-24 NEF
14S	29.36	42.87	14.28	7/8-20 NEF	3/4-20 NEF
14	29.36	52.37	19.05	7/8-20 NEF	3/4-20 NEF
16S	31.75	42.87	14.28	1-20 NEF	7/8-20 NEF
16	31.75	52.37	19.05	1-20 NEF	7/8-20 NEF
18	34.13	52.37	19.05	1 1/8-18 NEF	1-20 NEF
20	37.31	55.57	19.05	1 1/4-18 NEF	1 3/16-18 NEF
22	40.48	55.57	19.05	1 3/8-18 NEF	1 3/16-18 NEF
24	43.66	58.72	20.63	1 1/2-18 NEF	1 7/16-18 NEF
28	50.01	58.72	20.63	1 3/4-18 NS	1 7/16-18 NEF
32	56.36	67.92	22.23	2-18 NS	1 3/4-18 NS
36	62.71	67.92	22.23	2 1/4-16 UN	2-18 NS

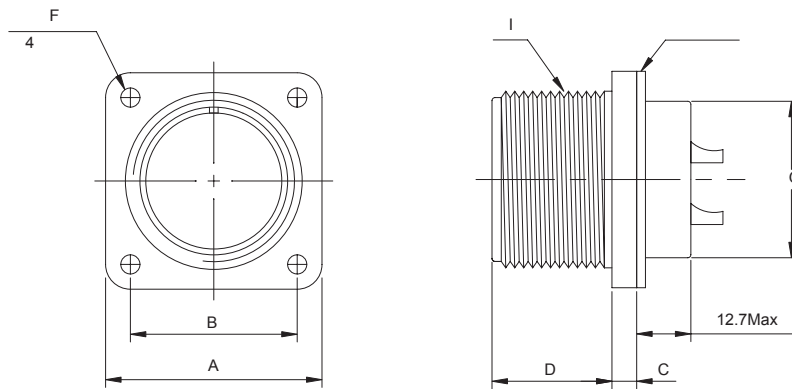
MS3102A

(mm)

	$\square A$ ± 0.79	$\square B$ ± 0.12	C ± 0.50	D $+0.79$ -0.00	$\varnothing F$ $+0.25$ -0.12	$\varnothing G$ Max	I UNEF-2A
10SL	25.40	18.26	3.00	14.28	3.05	16.00	5/8-24 NEF
12S	27.80	20.62	3.00	14.28	3.05	16.50	3/4-20 NEF
12	27.80	20.62	3.00	19.05	3.05	16.50	3/4-20 NEF
14S	30.20	23.01	3.00	14.28	3.05	20.00	7/8-20 NEF
14	30.20	23.01	3.00	19.05	3.05	20.00	7/8-20 NEF
16S	32.50	24.61	3.00	14.28	3.05	23.00	1-20 NEF
16	32.50	24.61	3.00	19.05	3.05	23.00	1-20 NEF
18	34.90	26.97	4.00	19.05	3.05	26.00	1 1/8-18 NEF
20	38.10	29.36	4.00	19.05	3.05	29.00	1 1/4-18 NEF
22	41.30	31.75	4.00	19.05	3.05	32.50	1 3/8-18 NEF
24	44.50	34.93	4.00	20.63	3.73	35.50	1 1/2-18 NEF
28	50.80	39.67	4.00	20.63	3.73	42.00	1 3/4-18 NEF
32	57.20	44.45	4.00	22.23	4.39	48.00	2-18 NS
36	63.50	49.23	4.00	22.23	4.39	54.50	2 1/4-16 UN

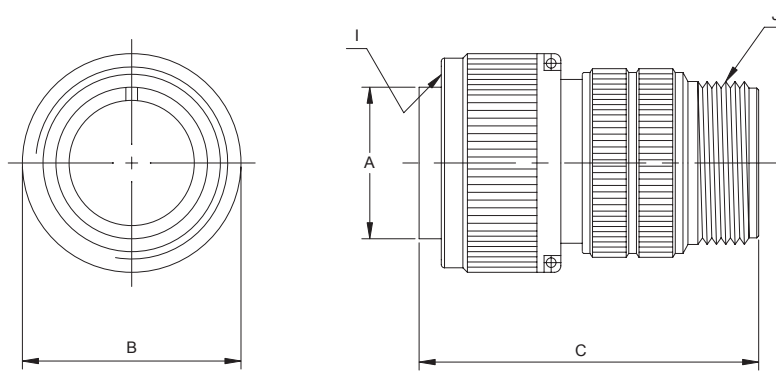

MS3106A

3100, 3101 3102.

(mm)

	$\varnothing A$ +0.00 -0.38	$\varnothing B$ Max	C Max	I UNEF-2B	J UNEF-2A
10SL	11.33	24.61	38.88	5/8-24 NEF	5/8-24 NEF
12S	14.10	26.97	42.87	3/4-20 NEF	5/8-24 NEF
12	14.10	26.97	52.37	3/4-20 NEF	5/8-24 NEF
14S	17.15	29.36	42.87	7/8-20 NEF	3/4-20 NEF
14	17.15	29.36	52.37	7/8-20 NEF	3/4-20 NEF
16S	20.45	31.75	42.87	1-20 NEF	7/8-20 NEF
16	20.45	31.75	52.37	1-20 NEF	7/8-20 NEF
18	23.62	34.13	52.37	1 1/8-18 NEF	1-20 NEF
20	26.67	37.31	55.57	1 1/4-18 NEF	1 3/16-18 NEF
22	29.85	40.48	55.57	1 3/8-18 NEF	1 3/16-18 NEF
24	33.02	43.66	58.72	1 1/2-18 NEF	1 7/16-18 NEF
28	38.61	50.01	58.72	1 3/4-18 NS	1 7/16-18 NEF
32	44.96	56.36	67.92	2-18 NS	1 3/4-18 NS
36	50.29	62.71	67.92	2 1/4-16 UN	2-18 NS

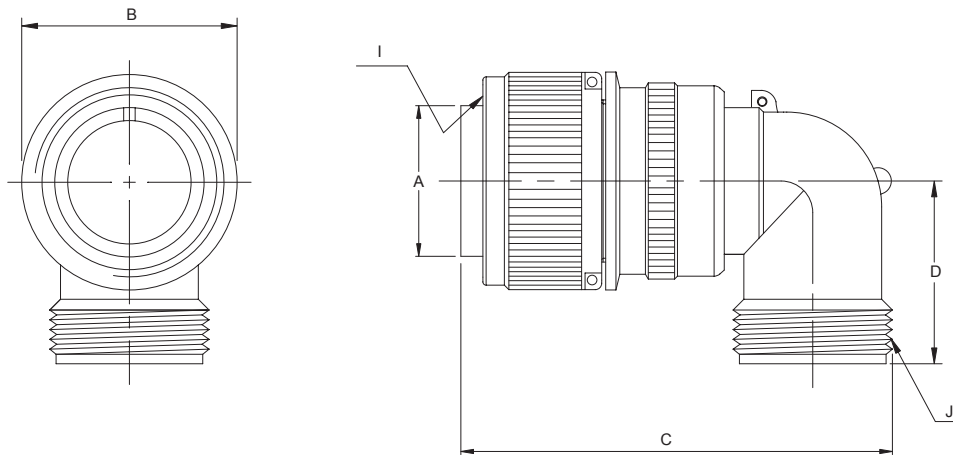

MS3108A

 3108
 (mm)

	$\varnothing A$ +0.00 -0.38	$\varnothing B$ Max	C Max	D Max	I UNEF-2B	J UNEF-2A
10SL	11.33	24.61	46.02	25.40	5/8-24 NEF	5/8-24 NEF
12S*	14.10	26.97	50.80	26.90	3/4-20 NEF	5/8-24 NEF
12	14.10	26.97	57.15	26.90	3/4-20 NEF	5/8-24 NEF
14S	17.15	29.36	53.97	28.50	7/8-20 NEF	3/4-20 NEF
14	17.15	29.36	58.72	28.50	7/8-20 NEF	3/4-20 NEF
16S	20.45	31.75	60.32	30.10	1-20 NEF	7/8-20 NEF
16	20.45	31.75	65.07	30.10	1-20 NEF	7/8-20 NEF
18	23.62	34.13	68.27	33.30	1 1/8-18 NEF	1-20 NEF
20	26.67	37.71	76.98	34.90	1 1/4-18 NEF	1 3/16-18 NEF
22	29.85	40.48	76.98	34.90	1 3/8-18 NEF	1 3/16-18 NEF
24	33.02	43.66	86.51	39.60	1 1/2-18 NEF	1 7/16-18 NEF
28	38.61	50.01	86.51	39.60	1 3/4-18 NS	1 7/16-18 NEF
32	44.96	56.36	95.25	47.60	2-18 NS	1 3/4-18 NS
36	50.29	62.71	100.02	52.30	2 1/4-16 UN	2-18 NS

* No Tooling



MIL-C-5015

MS-A

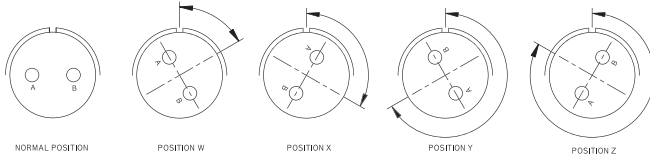

			0	4	8	12	16	W	X	Y	Z	
10SL-2	A	1					1	-	-	-	-	
10SL-3	A	3					3	-	-	-	-	
10SL-4	A	2					2	63	-	-	-	
12S-1	A	2					2	-	-	-	-	
12S-3	A	2					2	70	145	215	290	
12S-5	D	1				1		-	-	-	-	
14S-1	A	3					3	-	-	-	-	
14S-2	Inst	4					4	-	120	240	-	
14S-5	Inst	5					5	-	110	-	-	
14S-6	Inst	6					6	-	-	-	-	
14S-7	A	3					3	90	180	270	-	
14S-9	A	2					2	70	145	215	290	
14S-07	A	7					7	-	-	-	-	
16S-1	A	7					7	80	-	-	280	
16S-4	D	2					2	35	110	250	325	
16S-5	A	3					3	70	145	215	290	
16S-8	A	5					5	-	170	265	-	
16-9	A	4				2	2	35	110	250	325	
16-10	A	3					3	90	180	270	-	
16-11	A	2					2	35	110	250	325	
16-12	A	1				1		-	-	-	-	
16-13	A	2					2	35	110	250	325	
18-1	A/Inst	10					10	70	145	215	290	
18-3	D	2					2	35	110	250	325	
18-4	D	4					4	35	110	250	325	
18-5	D	3					2	1	80	110	250	280
18-8	A	8					1	7	70	-	290	
18-9	Inst.	7					2	5	80	110	250	280
18-10	A	4					4	-	120	240	-	
18-11	A	5					5	-	170	265		
18-12	A	6					6	80	-	-	280	
18-13	A	4				1	3	80	110	250	280	
18-15	A	4					4	-	120	240	-	

			0	4	8	12	16	W	X	Y	Z	
18-19	A	10					10	-	120	240	-	
18-20	A	5					5	90	180	270	-	
18-21	A	3					3	-	-	-	-	
18-22	D	3					3	70	145	215	290	
18-32	A	8					8	-	-	-	-	
20-2	D	1	1					-	-	-	-	
20-3	D	3					3	40	145	215	290	
20-4	D	4					4	45	110	250	-	
20-7	D/A	8					8	80	110	250	280	
20-8	Inst.	6				2	4	80	110	250	280	
20-11	Inst.	13					13	-	-	-	-	
20-15	A	7					7	80	-	-	280	
20-16	A	9					2	7	80	110	250	280
20-17	A	6					5	1	90	180	270	-
20-18	A	9					3	6	35	110	250	325
20-19	A	3					3	90	180	270	-	
20-22	A	6					3	3	80	110	250	280
20-23	A	2					2	35	110	250	325	
20-27	A	14					14	35	110	250	325	
20-29	A	17					17	80	-	-	20	
20-33	A	11					11	-	-	-	-	
20-01	A	10					10	-	-	-	-	
22-1	D	2					2	35	110	250	325	
22-2	D	3					3	70	145	215	290	
22-4	A	4					2	2	35	110	250	325
22-7	E	1	1					-	-	-	-	
22-8	E	2					2	35	110	250	325	
22-9	E	3					3	70	145	215	290	
22-10	E	4					4	35	110	250	325	
22-11	B	2					2	35	110	250	325	
22-12	D	5					2	3	80	110	250	280
22-13	D/A	5					4	1	34	110	250	325
22-14	A	19					19	80	110	250	280	



MIL-C-5015

MS-A

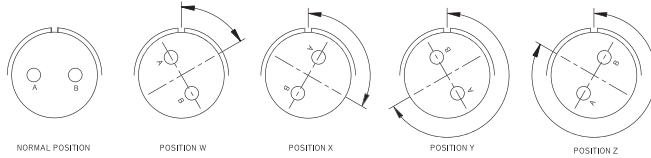

								W	X	Y	Z
			0	4	8	12	16				
22-15	E/A	6				5	1	80	110	250	280
22-18	A/D	8					8	80	110	250	280
22-19	A	14					14	80	110	250	280
22-20	A	9					9	35	110	250	325
22-21	A	3	1				2	-	-	-	-
22-22	A	4			4			-	110	250	-
22-23	D/A	8				8		35	-	250	-
22-27	D/A	9			1		8	80	-	250	280
22-28	A	7				7		80	-	-	280
24-2	D	7				7		80	-	-	28
24-5	A	16					16	80	110	250	280
24-6	D/A	8				8		80	110	250	280
24-7	A	16				2	14	80	110	250	280
24-9	A	2		2				35	110	250	325
24-10	A	7			7			80	-	-	280
24-11	A	9			3	6		35	110	250	32
24-12	A	5		2		3		80	110	250	280
24-20	D	11				2	9	80	110	250	280
24-22	D	4			4			45	110	250	-
24-28	Inst	24					24	80	110	250	280
24-02	A	9				9		-	-	-	-
24-03	A	12					12	-	-	-	-
28-1	D/A	9			3	6		80	110	250	280
28-3	E	3			3			70	145	215	290
28-6	D	3		3				70	145	215	290
28-7	D	2		2				35	110	250	325
28-9	D	12				6	6	80	110	250	280
28-10	D/A	7		2	2	3		80	110	250	280
28-11	A	22				4	18	80	110	250	280
28-12	A	26					26	90	180	270	-
28-15	A	35					35	80	110	250	280
28-16	A	20					20	80	110	250	280
28-17	B/D/A	15					15	-	-	-	-

								W	X	Y	Z	
			0	4	8	12	16					
28-18	A	12					12	-	-	-	-	
28-19	B/D/A	10					4	6	80	110	250	280
28-20	A	14					10	4	80	110	250	280
28-21	A	37						37	80	110	250	280
28-22	D	6		3				3	70	145	215	290
28-05	A	5			5				-	-	-	-
28-51	A	12					12		-	-	-	-
32-1	E/D	5	2			3		80	110	250	280	
32-5	D	2	2					35	110	250	325	
32-6	A	23		2	3	2	16	80	110	250	325	
32-7	INST/A	35				7	28	80	125	235	280	
32-8	A	30				6	24	80	125	235	280	
32-9	D	14		2			12	80	110	250	280	
32-15	D	8	2			6		35	110	250	280	
32-17	D	4		4				45	110	250	280	
32-22	A	54					54	80	110	250	280	
32-03	A	3		3				-	-	-	-	
32-59	A	42			2		40	-	-	-	-	
36-1	D	22				4	18	80	110	250	280	
36-3	D	6	3			3		70	145	215	290	
36-4	D/A	3	3					70	145	215	290	
36-5	A	4	4					-	120	240	-	
36-7	A	47				7	40	80	110	250	280	
36-8	A	47				1	46	80	110	250	280	
36-9	A	31		1	2	14	14	80	125	235	280	
36-10	A	48					48	80	125	235	280	
36-15	D/A	35					35	60	125	245	305	
36-30	A	30				30		-	-	-	-	
36-40	A	40				22	18	-	-	-	-	
36-52	A	52					52	72	144	216	288	
36-02	A	27				27		-	-	-	-	
36-03	A	20				20		-	-	-	-	
36-04	A	22				22		-	-	-	-	



MIL-C-5015

MS-A

	Front of Socket Insert	Front of Socket Insert				
10SL-2	10SL-3	10SL-4	12S-1	12S-3	12S-5	14S-1
A	A	A	A	A	D	A
1	3	2	2	2	1	3
16	16	16	16	16	12	16
14S-2	14S-5	14S-6	14S-7	14S-9	14S-07	16S-1
Inst.	Inst.	Inst.	A	A	A	A
4	5	6	3	2	7	7
16	16	16	16	16	16	16
16S-4	16S-5	16S-8	16-9	16-10	16-11	
D	A	A	A	A	A	
2	3	5	2 2	3	2	
16	16	16	12 16	12	12	

CONTACT LEGEND 16 12 8 4 0



MIL-C-5015

MS-A

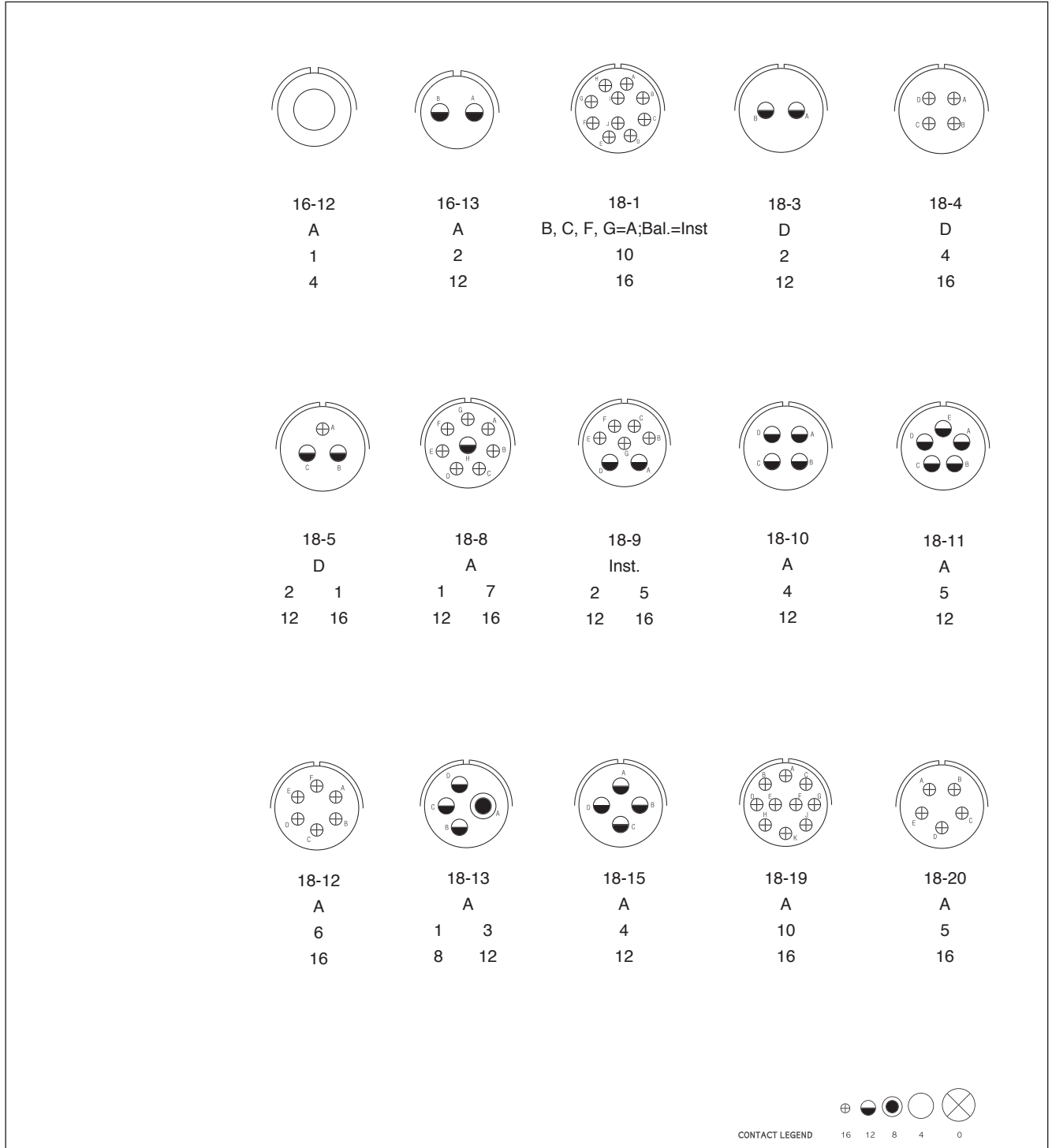



MIL-C-5015

MS-A

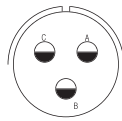

18-21
A
3
12

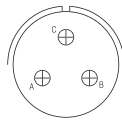

18-22
D
3
16

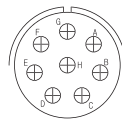

18-32
A
8
16

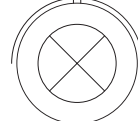

20-2
D
1
0

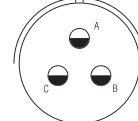

20-3
D
3
12

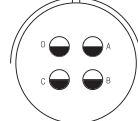

20-4
D
4
12

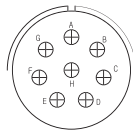

20-7
H, G=D: C, D, E, F=A
8
16

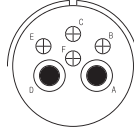

20-8
Inst.
2 4
8 16

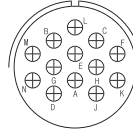

20-11
Inst.
13
16

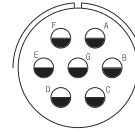

20-15
A
7
12

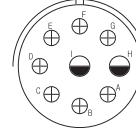

20-16
A
2 7
12 16

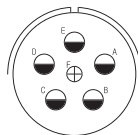

20-17
A
5 1
12 16

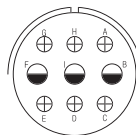

20-18
A
3 6
12 16

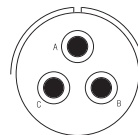

20-19
A
3
8

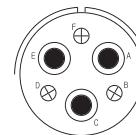

20-22
A
3 3
8 16



CONTACT LEGEND 16 12 8 4 0



MIL-C-5015

MS-A

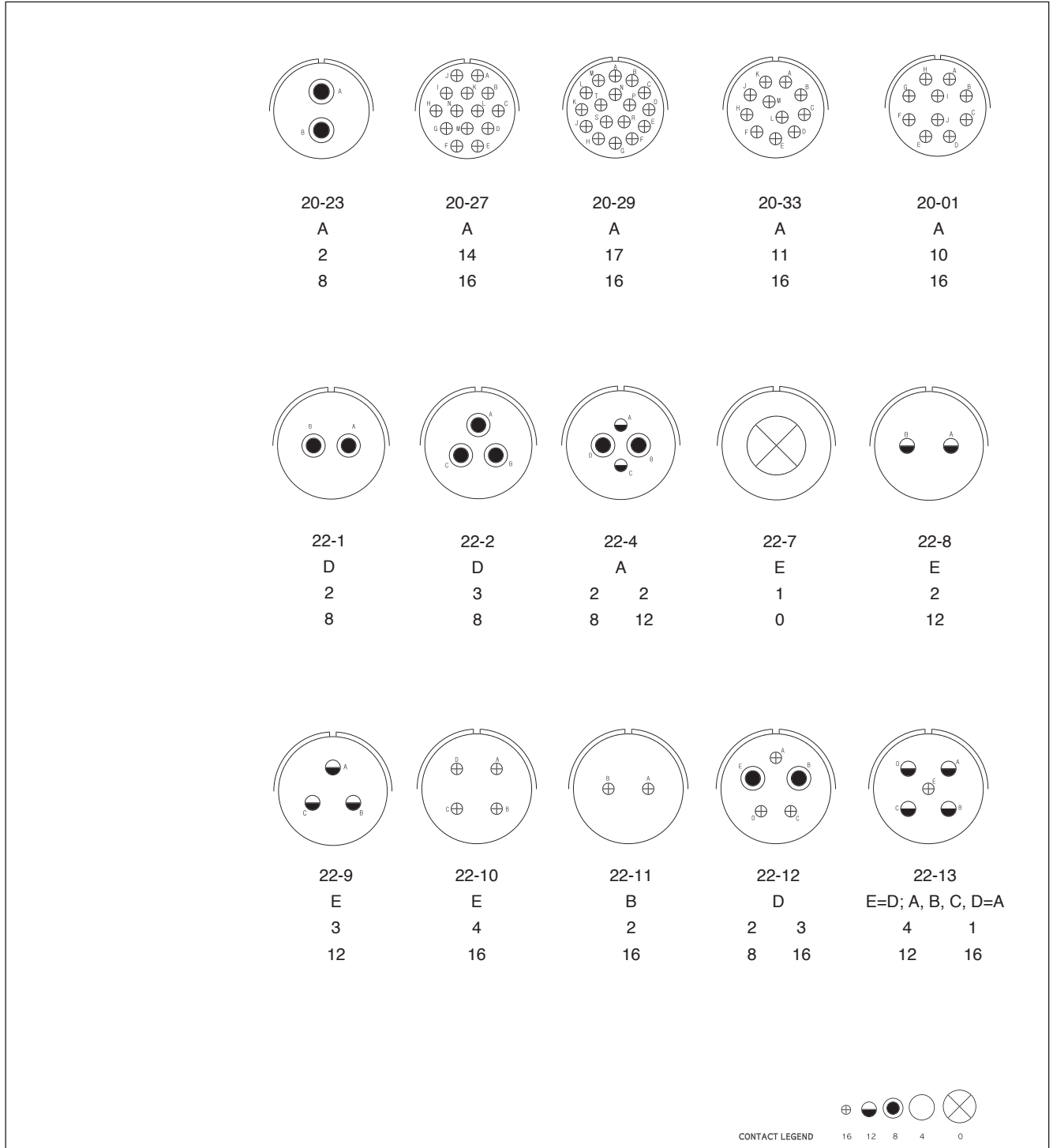



MIL-C-5015

MS-A

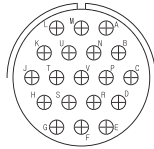

22-14
A
19
16

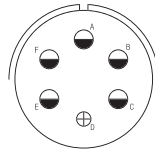

22-15
D=E; A, B, C, E, F=A
5 1
12 16

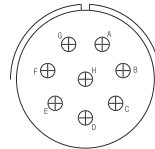

22-18
A,B,F,G,H=D; C,D,E=A
8
16

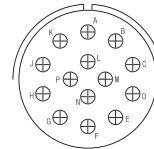

22-19
A
14
16

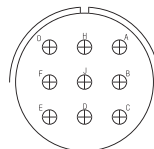

22-20
A
9
16

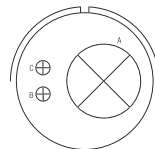

22-21
A
1 2
0 16

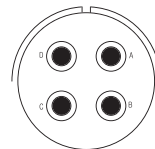

22-22
A
4
8

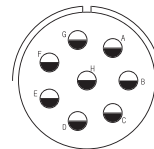

22-23
H=D; Bal.=A
8
12

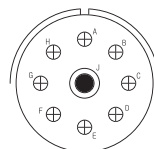

22-27
J=D; Bal.=A
1 8
8 16

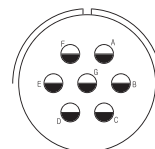

22-28
A
7
12

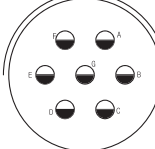

24-2
D
7
12

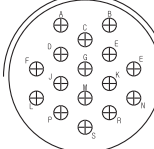

24-5
A
16
16



CONTACT LEGEND

16 12 8 4 0



MIL-C-5015

MS-A

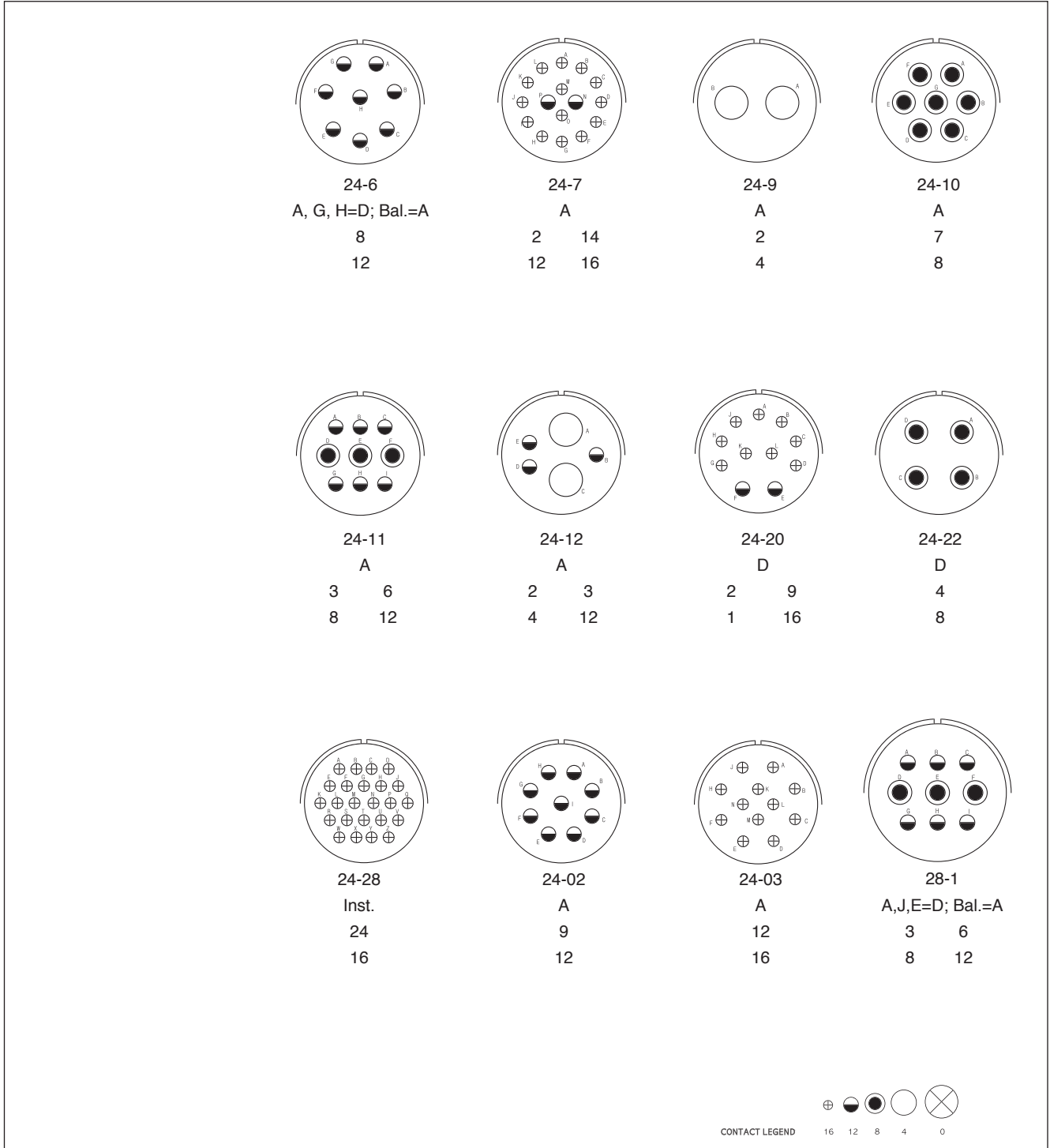

MIL-C-5015

MS-A

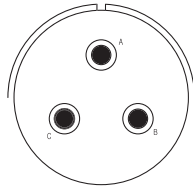

28-3
E
3
8

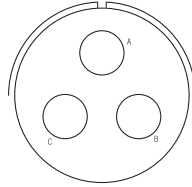

28-6
D
3
4

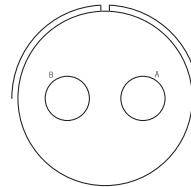

28-7
D
2
4

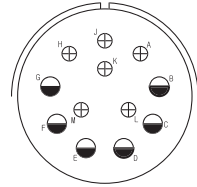

28-9
D
6 6
12 16

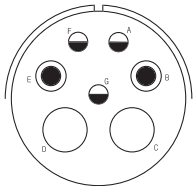

28-10
G=D; Bal. A
2 2 3
4 8 12

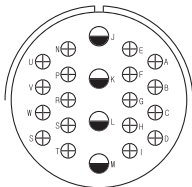

28-11
A
4 18
12 16

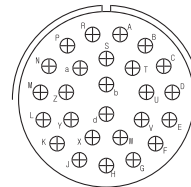

28-12
A
26
16

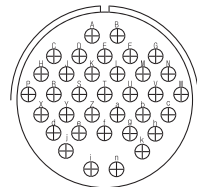

28-15
A
35
16

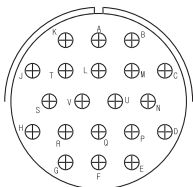

28-16
A
20
16

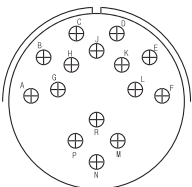

28-17
R=B;M,N,P=D;A to L=A
15
16

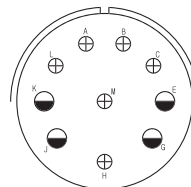

28-19
H,M=B;A,B=D;Bal.=A
4 6
12 16

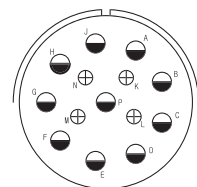

28-20
A
10 4
12 16



CONTACT LEGEND 16 12 8 4 0



MIL-C-5015

MS-A

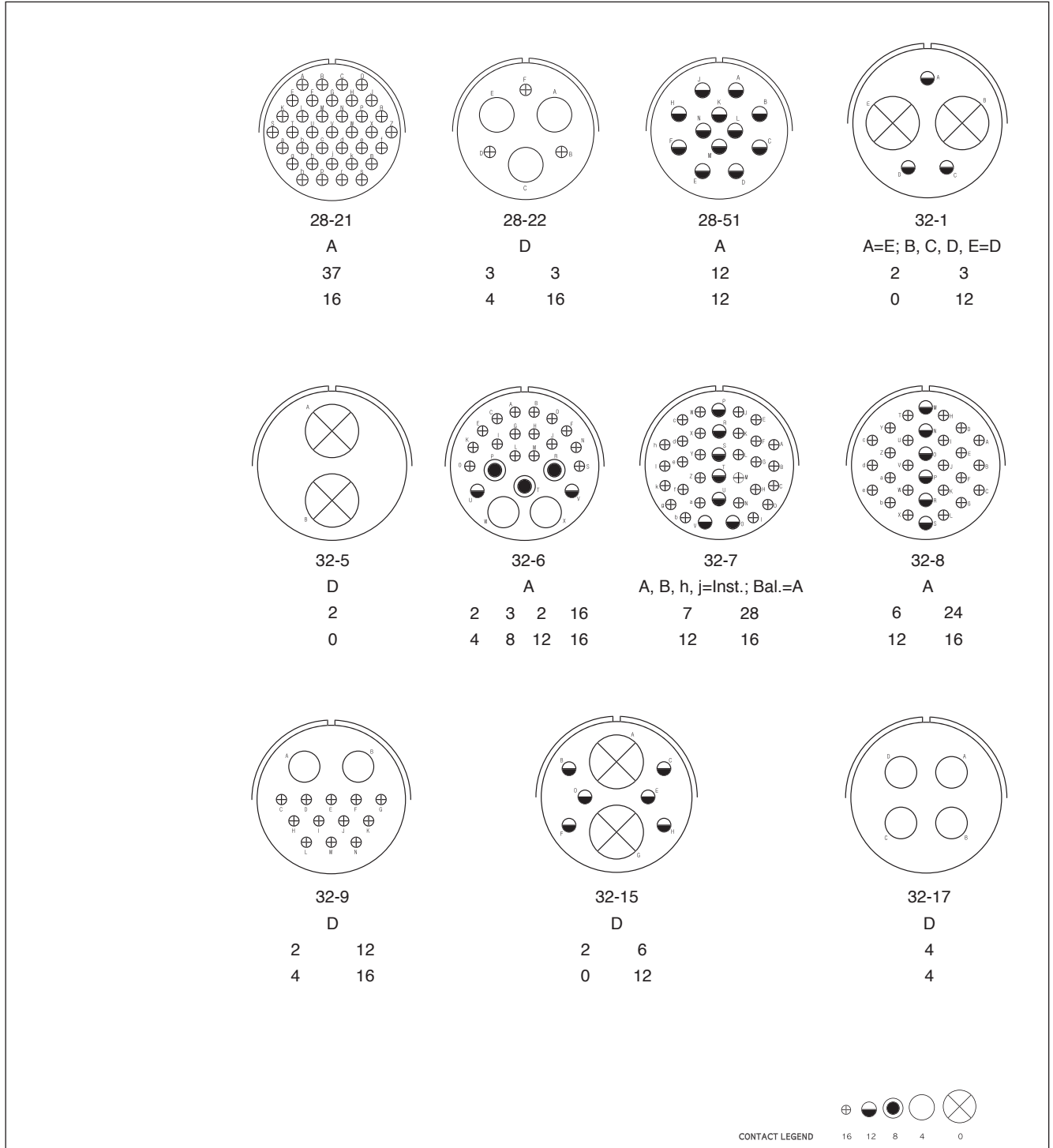



MIL-C-5015

MS-A

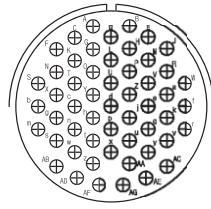

32-22
A
54
16

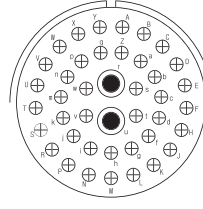

32-59
A
2 40
8 16

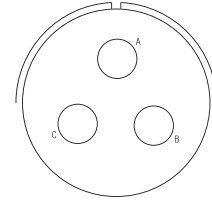

32-03
A
3
4

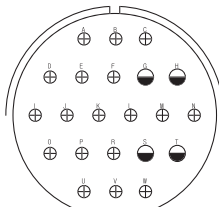

36-1
D
4 18
12 16

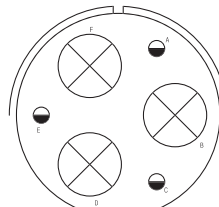

36-3
D
3 3
0 12

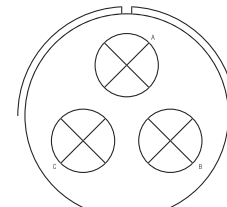

36-4
A=D; B, C=A
3
0

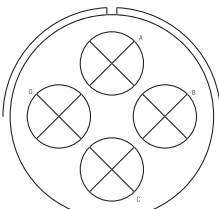

36-5
A
4
0

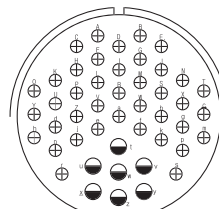

36-7
A
7 46
12 16

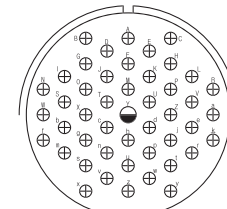

36-8
A
1 46
12 16



CONTACT LEGEND 16 12 8 4 0



MIL-C-5015

MS-A

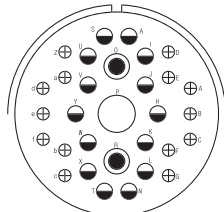

36-9
A
1 2 14 14
4 8 12 16

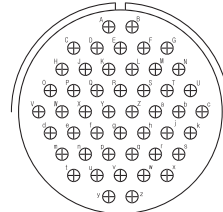

36-10
A
48
16

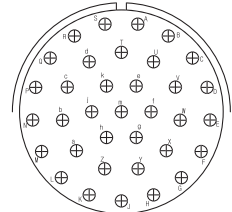

36-15
M=D; Bal.=A
35
16

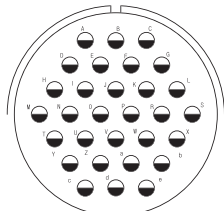

36-30
A
30
12

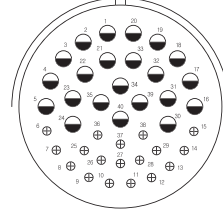

36-40
A
22 18
12 16

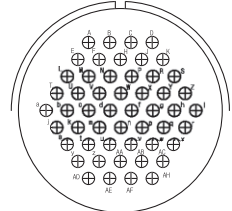

36-52
A
52
16

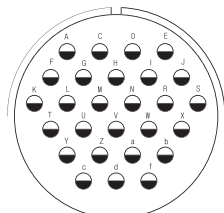

36-02
A
27
12

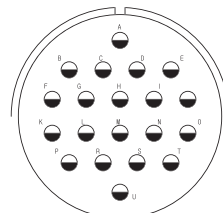

36-03
A
20
12

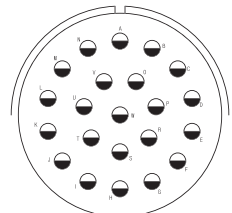

36-04
A
22
12



CONTACT LEGEND

16 12 8 4 0

MIL-C-5015

MS



MS3057

MS3057

MS3420.

MIL-C-5015

MS

MS25042

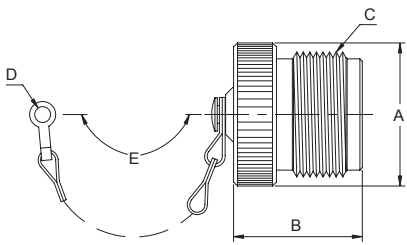

		$\varnothing A$ MAX	$\varnothing B$ MAX	C UNEF-2A	$\varnothing D$ -0.3	E Approx
MS25042-10D	10S,10SL	18.5	17.2	5/8-24 NEF	4.2	102
MS25042-12D	12S,12	20.4	21.4	3/4-20 NEF	4.2	114
MS25042-14D	14S,14	23.6	21.4	7/8-20 NEF	4.2	114
MS25042-16D	16S,16	26.0	21.4	1-20 NEF	4.2	114
MS25042-18D	18	29.9	21.4	1/8-18 NEF	4.2	114
MS25042-20D	20	33.1	21.4	1/4-18 NEF	4.2*	127
MS25042-22D	22	36.2	21.4	3/8-18 NEF	4.2*	127
MS25042-24D	24	39.4	21.4	1/2-18 NEF	4.2*	140
MS25042-28D	28	45.7	21.4	3/4-18 NS	4.2*	197
MS25042-32D	32	52.0	21.4	2-18 NS	4.2**	197
MS25042-36D	36	59.0	21.4	1/4-16 UN	4.2**	197

MS3106 MS3108.

.(*5.0)(**5.8)

MS25043

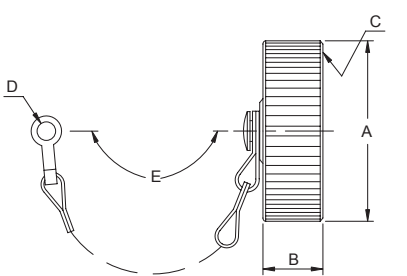

		$\varnothing A$ MAX	$\varnothing B$ MAX	C UNEF-2A	$\varnothing D$ -0.3	E Approx
MS25043-10D	10S,10SL	20.2	15.8	5/8-24 NEF	4.2	102
MS25043-12D	12S,12	23.4	15.8	3/4-20 NEF	4.2	114
MS25043-14D	14S,14	27.9	15.8	7/8-20 NEF	4.2	114
MS25043-16D	16S,16	29.8	15.8	1-20 NEF	4.2	114
MS25043-18D	18	32.2	15.8	1 1/8-18 NEF	4.2	114
MS25043-20D	20	36.3	15.8	1 1/4-18 NEF	4.2	127
MS25043-22D	22	39.9	15.8	1 3/8-18 NEF	4.2	127
MS25043-24D	24	43.7	15.8	1 1/2-18 NEF	4.2*	140
MS25043-28D	28	50.0	15.8	1 3/4-18 NS	4.2*	197
MS25043-32D	32	56.5	15.8	?-18 NS	4.2**	197
MS25043-36D	36	61.5	15.8	2 1/4-16 UN	4.2**	197

MS3100, MS3101 MS3102.

.(*4.58)(**5.00)

MIL-C-5015

MS

MS3057

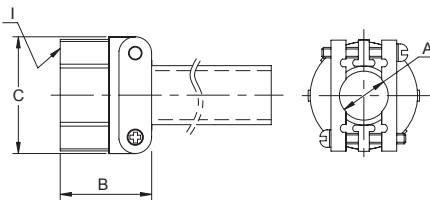

		$\varnothing A$ ± 0.4	B ± 0.8	$\varnothing C$ ± 0.8	I UNEF-2B
MS3057-4A	10SL,12S	5.6	20.3	23.3	5/8-24 NEF
MS3057-6A	14S,14	7.9	22.5	25.9	3/4-20 NEF
MS3057-8A	16S,16	11.1	24.4	28.9	7/8-20 NEF
MS3057-10A	18	14.3	23.6	32.2	1-20 NEF
MS3057-12A	20,22	15.9	23.6	37.8	1 3/16-18 NEF
MS3057-16A	24,28	19.1	26.0	43.4	1 7/16-18 NEF
MS3057-20A	32	23.8	27.7	52.1	1 3/4-18 NS
MS3057-24A	36	31.8	29.2	57.3	2-18 NS

MS3057

MS3420.

«1»

MS3420

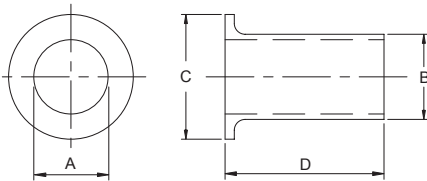

		$\varnothing A$ Max	$\varnothing B$ Max	$\varnothing C$	D
MS3420-4	10SL,12S	5.6	7.7	12.8	69.9
MS3420-6	14S,14	7.9	10.9	15.7	66.7
MS3420-8	16S,16	11.1	14.0	18.9	63.5
MS3420-10	18	14.3	15.6	22.6	60.3
MS3420-12	20,22	15.9	18.8	27.5	57.2
MS3420-16	24,28	19.1	23.6	33.4	54.0
MS3420-20	32	23.8	31.5	40.6	50.8
MS3420-24	36	31.8	34.7	46.9	47.6

(3057)

MIL-C-5015

MS

BMA 31

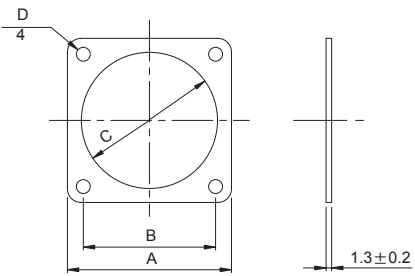

		□ A	□ B	∅ C	D +0.2
BMA31-10	10S,10SL	25.40	18.26	14.9	3.2
BMA31-12	12S,12	27.79	20.62	16.4	3.2
BMA31-14	14S,14	30.18	23.01	20.4	3.2
BMA31-16	16S,16	32.54	24.61	23.0	3.2
BMA31-18	18	34.94	26.97	25.9	3.2
BMA31-20	20	38.10	29.36	29.1	3.2
BMA31-22	22	41.28	31.75	32.0	3.2
BMA31-24	24	44.45	34.93	35.3	3.8
BMA31-28	28	50.80	39.67	41.5	3.8
BMA31-32	32	57.15	44.45	47.5	4.6
BMA31-36	36	63.50	49.23	54.7	4.6

()

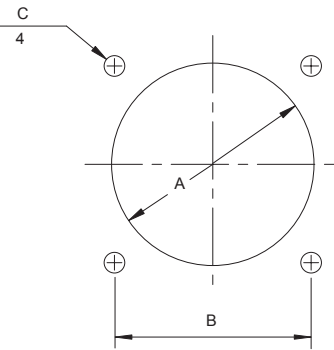

	∅ A ±0.5	□ B ±0.12	C +0.2
10SL	17.5	18.26	3.2
12S	18.5	20.62	3.2
12	18.5	20.62	3.2
14S	22.0	23.01	3.2
14	22.0	23.01	3.2
16S	25.0	24.61	3.2
16	25.0	24.61	3.2
18	30.0	26.97	3.2
20	33.0	29.36	3.2
22	35.0	31.75	3.2
24	39.0	34.93	3.8
28	45.0	39.67	3.8
32	52.0	44.45	4.6
36	59.0	49.23	4.6

MIL-C-5015

MIL-C-5015

A, B, E/F, R,

Renhotec,

MIL-C-5015.

MIL-C-5015

MIL-C-5015

1.

	5,000 Mega ohms (at 25 °C)
	-55°C to 125°C
	500 /

2.

Inst	g	AC(rms)		
			AC	DC
A		1,000	200	250
D		2,000	500	700
E		2,800	900	1,250
B		3,500	1,250	1,750
C		4,500	1,750	2,450
		7,000	3,000	4,200

3.

	()	()	()
#16	2	24	30
#12	3	24	30
#8	5	-	160
#4	10	-	240
#0	15	-	320

4.

	(MM)	(MM)			
				DC A	()mV
#16	1.6	1.9	13A	13A	49
#12	2.4	3.0	23A	23A	42
#8	3.6	5.4	46A	46A	26
#4	5.7	8.4	80A	80A	23
#0	9.1	12.2	150A	150A	21

5.

	A.W.G		
#16	#22~#16	≤1.3	1.7~3.3
#12	#14~#12	≤3.5	2.9~4.3
#8	#10~#8	≤8.0	4.2~6.4
#4	#6~#4	≤22.0	7.0~9.4
#0	#2~#0	≤50.0	10.6~14.0

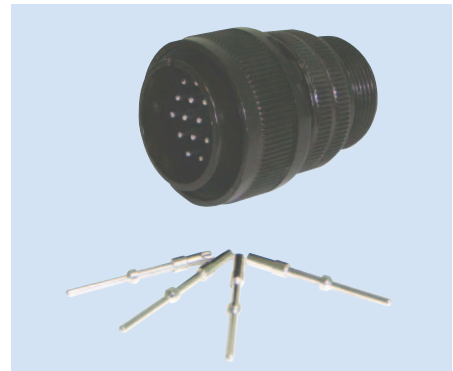

MIL-C-5015

MS/DS

MIL-C-5015 ()

MIL-C-5015 ()

MS 3102 A 18-10 P W XXX
1 2 3 4 5 6 7 8

MS 4102 A 18-10 P W XXX
1 2 3 4 5 6 7 8

1. MS -
DS - MIL-C-5015
2. 3100-
3101-
3102-
3106-
3108- 90°
3. A - , Solid Endbell
E - , &
- F -
& 3106F 3108E
- 4, 5. , 26.27
6. P- , (+)
S- , (-)
7. -
"W", "X", "Y", or "Z" - 26.27
8. - -
CD -
C1 - (+6 Cr)
621 -
689 -
426 -

1. MS -
2. 4100-
4101-
4102-
4106-
4108- 90°
3. Service Class
A - , Solid Endbell
E - , &
- F -
& 3106F 3108E
- 4, 5. , 26.27
6. P- , (+)
S- , (-)
7. -
"W", "X", "Y", or "Z" - 26.27
8. - -
CD -
C1 - (+6 Cr)
621 -
689 -
426 -